

— Restoration & Moisture & Ventilation —

ALORAIR

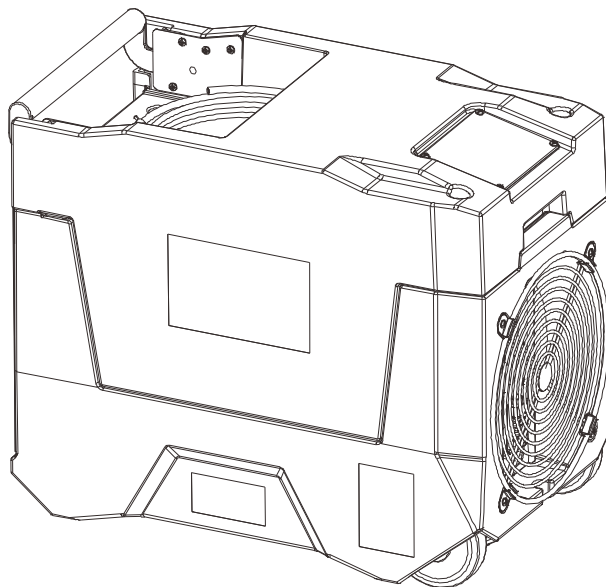

Storm SLGR 850C Installation and Operations Manual



READ AND SAVE THESE INSTRUCTIONS

Alorair Solutions INC.

Add: 4240 Latham Street, Suite D, Riverside, CA 92501

Tel: 888-990-7469

E-mail: Sales@alorair.com

Table of Contents

Safety Instructions	1
Identification	1
Electrical Supply	1
How the SLGR 850C Works	2
Guidelines	2
Parts Diagram	3
Using the Display- Main Screen	4
Maintenance Instructions	9
Troubleshooting	10
Warranty	11

Safety Instructions

- Don't adjust or alter the unit in any way.
- The use of unauthorized parts will void your warranty. Contact your approved distributor for assistance.
- Always unplug the unit prior to removing the cover.
- Inspect the power cord prior to use and do not use if it is damaged.
- The unit should only be used with a 115V/60Hz circuit protected by a GFCI outlet.

Identification

Prior to installation of the unit, write down the serial number and date of purchase. You will need this information if you need assistance in the future. The data label on the side of your unit has the necessary information.

Model Number: Storm SLGR 850C

Serial Number: _____ **Date of Purchase:** _____

For additional questions concerning your dehumidifier:

- Contact your installing contractor
- Contact Alorair Solutions : sales@alorair.com
888-990-7469

Electrical Supply

Power Supply: 115V/60Hz

Outlet Requirement: 3-Prong, GFCI

circuit protector: 15 Amp

WARNING: Using a 220V outlet may cause serious injury from electric shock.

To reduce risk of injury:

1. Always disconnect machine from electrical power before servicing
2. Only plug unit into a grounded electrical circuit
3. Do not use an extension cord
4. Do not use a plug adapter

How the Storm SLGR 850C works

The Storm SLGR 850C dehumidifier utilizes its integral humidistat to monitor the conditioned space. Once conditions are outside the desired setpoint, the compressor energizes and air is drawn across an evaporator coil. The evaporator coil is cooler than the dew point of the air so the water vapor will turn into liquid condensation. The air is then reheated through the condenser coil and distributed back into the room.

Guidelines

Operation Notes

- Always make sure that the unit is operated, transported, and stored on a stable surface.
- For maximum efficiency, operate the unit with all windows and doors closed.
- Do not place the unit anywhere that may block the inlet or outlet airflow.

Drain Hose Notes

- The Storm SLGR 850C is equipped with an external drain line connection, making it easy to plug in.
- The drain line can be directed outside or into any sink, drain, etc.
- For more effective draining, uncoil the entire hose before using.
- Never place the end of the hose higher than 15 feet.
- Always ensure that the drain hose is not blocked prior to use.

Transportation Notes

- Always secure the dehumidifier during transportation enter period.
- If the unit is transported vertically, return it to a normal horizontal position, and let sit for 30 minutes prior to use.

Parts Diagram

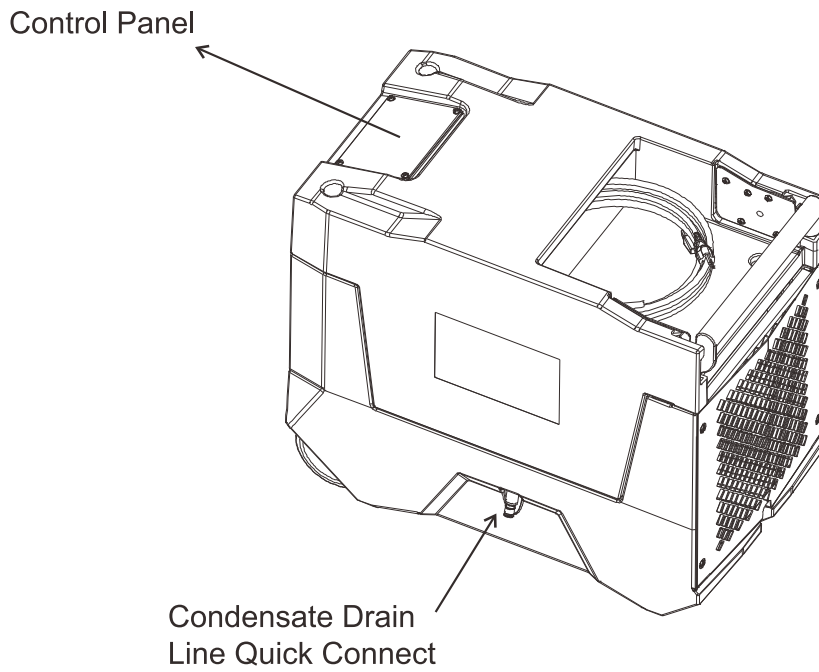
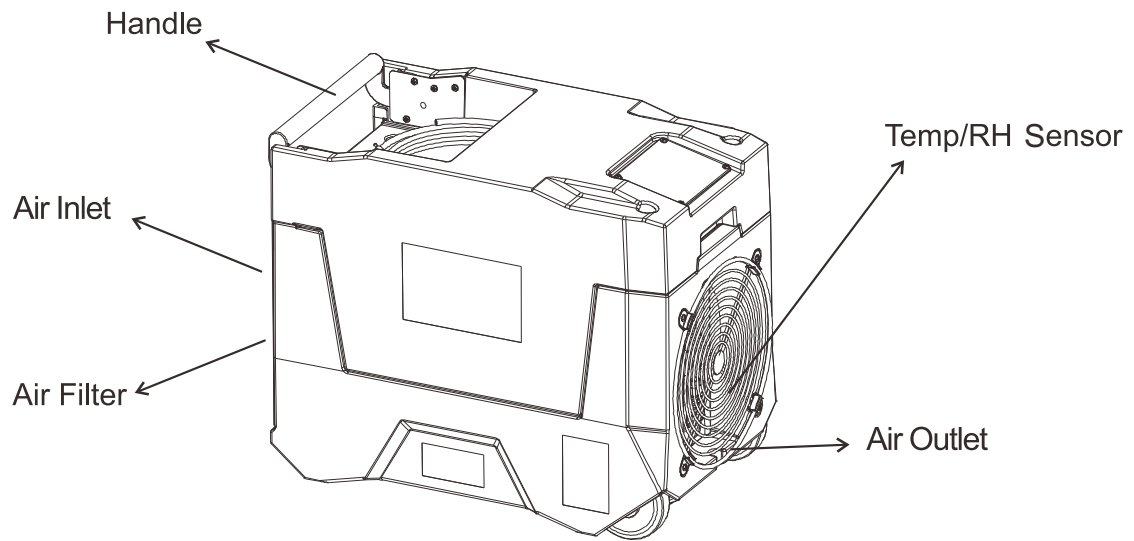

※ LCD Display Instructions ※

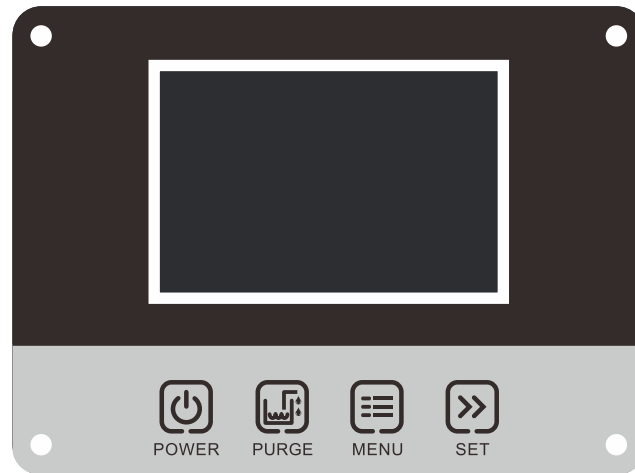

1. When the machine is powered on but not working: (after power on, the buzzer makes a sound)



Boot display: The LOGO interface will disappear after 2 seconds. Enter the following interface



The machine displays when it is not working. (Power off state but have electricity)

2. Main interface display of dehumidification state:

The following information is displayed when the machine is working:

• **000 JOB HRS:**

Refers to the working time, which is defined as the time from starting up to shutting down, including the defrost time during the period, and the standby time after the humidity. The submenu has a reset function. If not, the working time shall be accumulated.

Total time 9999 hours, the largest cumulative to the largest automatically reset after restart, and display units for hours. (round off).

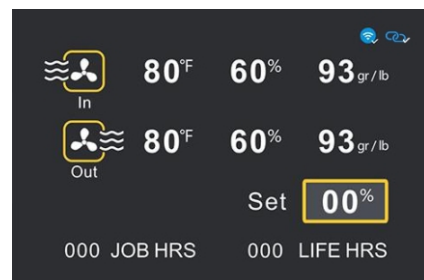

• **000 LIFE HRS:**

Refers to the total working time, i.e. the total working time (hours), which is in hours.(press the mode key + select the confirmation key, and the total working time will be cleaned after 3 seconds.

• **IN/OUT 00°F 00% 00 gr / lb:**

Indicates the temperature, humidity and moisture content of the air inlet and outlet {GPP - grain per pound (gr/lb)}.

• **Set 00%:**

Indicates set humidity.

• If the main interface does not operate for 10 minutes, the screen will go out.Press any key to wake up.

• Other icons light up or flicker when opened

The total working time is the accumulation of each working time (hours) in hours. (Press the mode key + select to confirmation key, and the total working time will be cleaned after 3 seconds.

3.Dehumidification status submenu interface display

3.1

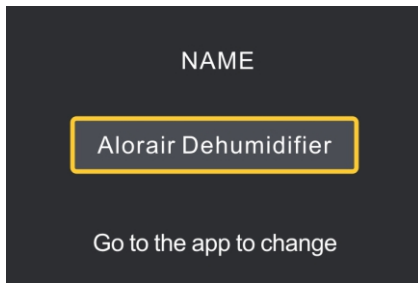

Device name displayed on the screen:

You can change the device name on the APP application

3.2

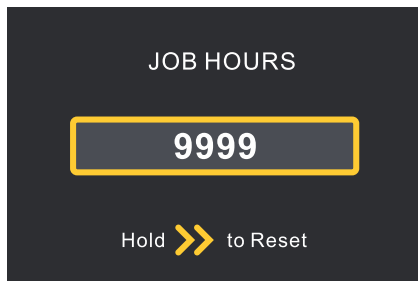

“Indicates”:Do I need to clear out this time?", press ">"if you need to clear. When the operation is completed, the working time of the main interface and the working time of this interface will be reset and started to be instant again. After accumulation (9999), clean up and round.

3.3

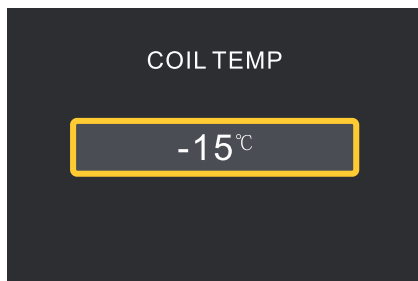

“Coil Temp 000°C ”: Used to display the current temperature of the coil.When it is below zero, the "-" symbol is displayed in front. "-" is not required on zero.

3.4

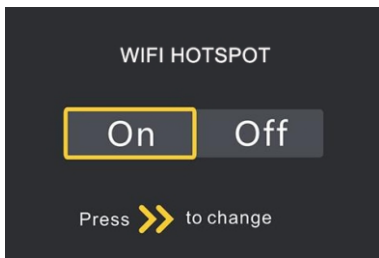

Wifi hotspot: factory setting is "OFF", press > to enable wifi hotspot and switch ON/OFF. The device can transmit data and receive APP commands. The icon flickers when connected on the main interface. After successful connection, the icon displays normally.

3.5.1

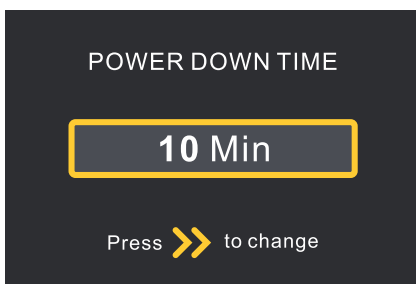

The power down time is adjusted according to ">" and the power down time increases from 3 to 20 minutes (3-5-10-15-20), which is the so-called stop time of the fan after shutdown, in order to better drain the water. Factory set for 3 minutes. (the other state of the fan is still 15 seconds.)

3.5.2

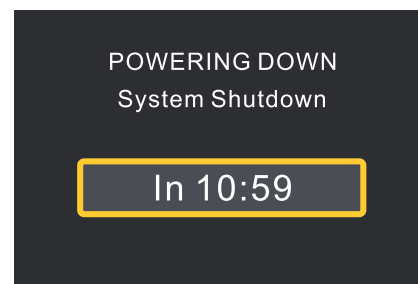

The screen displays when you press shut down:
Indicates: the fan is closed after a few minutes, and the standby page UNIT OFF is displayed after the fan is closed.

3.6

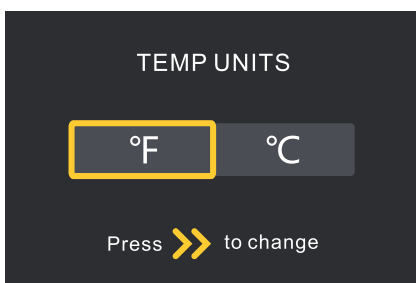

“Temp Units °F/°C”: Used for temperature scale switching. Press the ">" button to switch °F / °C, after switch symbol of corresponding parts is also changing.

3.7

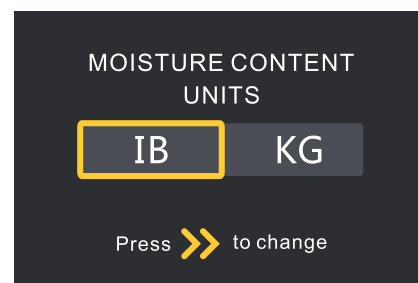

“MOISTURE CONTENT UNITS”: It is used to switch the unit of GPP value with moisture content. Press > to switch the lb or Kg, after switch symbol of corresponding parts is also changing.

3.8

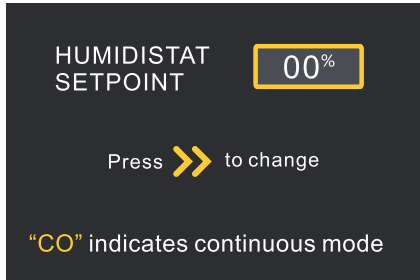

"Humidistat Setpoint 00%":Used for setting dehumidification mode humidity.Press ">" to set the humidity. The adjustment range of humidity setting is between 25 and 80%. Each key rises or falls 5%, which can be recycled.

When the setting is completed,do not operate for 5 seconds and begin to take effect.(Otherwise, the compressor will be shut down immediately after it is below ambient humidity at the time of setting.) Humidity below 25 percents "CO" mode recyclable.The main interface displays the set parameters.

4. Main interface frosting status display:

The machine will display this after defrost when running

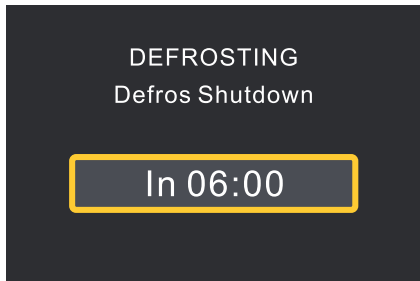

When the machine is running normally, "Deffrost SHUTDOWN IN 06:00" will occurs in the interface after defrosting. It's defrost countdown use seconds as units. This screen displays only 3 seconds. Displays the previous interface and status after restoration.If it is the home screen, the frost icon will flash.

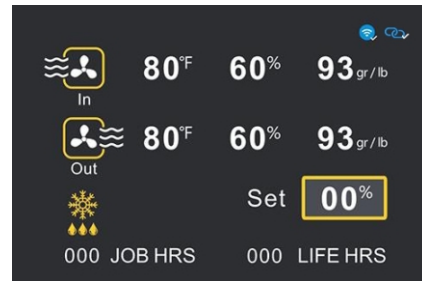

When the user is operating in the submenu, the machine is in the frosting state.At this point, the frosting interface displays 3 seconds, and returns to the submenu program in the background countdown.When the user returns to the main interface without any operation, the frosting state is displayed inthe main interface in the way of icon flicker.

5. Compressor on waiting interface display

Compressor protection time not shown:

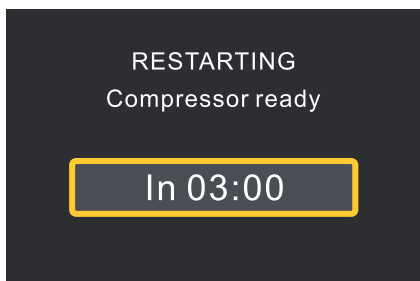

"Compressor ready IN 03:00" indicates : That the interface will be displayed when the compression is in a protected state. (including power-on and shutdown, the humidity rises immediately after the arrival of L0 HI, and the shutdown resumesimmediately after the emergence of L0 HI).Displays the countdown in seconds.If the above situation does not occur within 3 minutes, it is not shown.

6. Water Pump working interface display

Compressor protection time not shown:

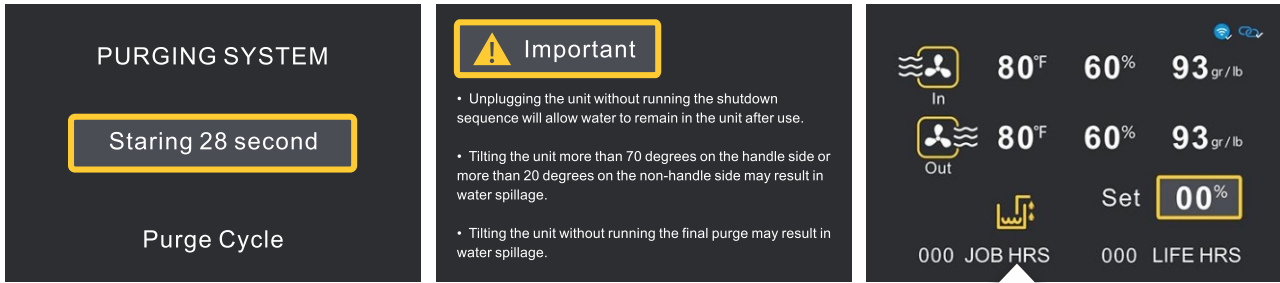

“**Pump working countdown**”: indicates: No matter in which working state and interface, as long as the pump works, this interface appears and counts down to 28 seconds. However, the interface only displays the previous working status and interface after 3 seconds. For example, after 3 seconds, there is a drainage icon on the main interface and it will flash until the drainage is finished.

7. Interface display in case of failure

Machine running time fault display:

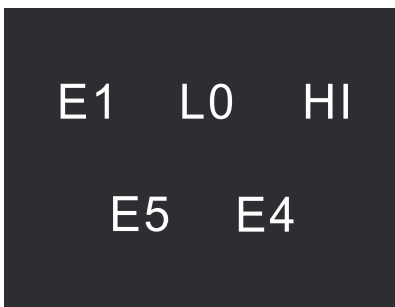

Make fault judgment and take corresponding actions after starting up. Regardless of the state, the fault is executed first and the fault code is displayed on the interface. If there is a fault in the sub-menu operation, immediately return to this interface display fault (including defrosting state). (the fault is judged when the pump works, and the fault is displayed as usual, but the pump needs to complete the water pumping this time). Multiple faults can be displayed at the same time.

Description of fault display:

- ◆ Humidity sensor fault: when the humidity sensor unit fault or signal can not be transmitted, the fault is judged to be E1. The machine is out of operation (power on again after troubleshooting). Pump button can operate.
- ◆ Ambient temperature $T \leq 2$: When the sensor continuously detects the ambient temperature of inlet air $T = 2$ degrees for 600 seconds, the fault is judged to be LO and the whole machine is stopped. Other values, corresponding to the temperature region operation. (recoverable). At this time, the interface cannot be operated. The pump button can be operated.
- ◆ Ambient temperature $T \geq 45$: When the sensor continuously detects the inlet air environment temperature $T = 45$ degrees for 15 seconds, the fault is judged to be HI and the whole machine is stopped. Other values, corresponding to the temperature region operation. (recoverable). At this time, the interface cannot be operated. The pump button can be operated.

Maintenance Instructions

Before Use

- Check the power cord for signs of damage such as fraying. Replace the cord before use if there is any damage.
- Check the filter for signs of dirt or obstructions. Clean or replace the filter as necessary.
- Check the coils for signs of buildup. Clean if needed.

Cleaning the Machine Body

Use a soft, damp cloth to clean the exterior of the unit. Do not use any soap or solvents.

Filter Maintenance

1. Unplug the unit.
2. Slide out the filter.
3. Check the filter for dirt and buildup.
4. **For a Pre-Filter or MERV-8:**

Clean the filter mesh by vacuuming it or washing with warm water (no soap or cleaners). Gently shake the filter dry, then reinsert it.

5. **For a Carbon, or HEPA Filter:**
If there is dirt or buildup, replace filter.

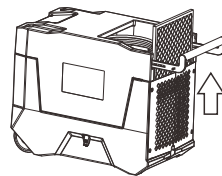

Removing the Housing

1. Remove the screws on the housing.
2. Remove the screws on the air inlet grill and air outlet grill.

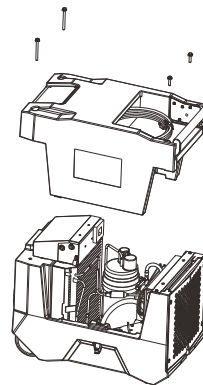

Coil Maintenance

- Once per year, clean the coils with an approved coil cleaner.
- Coil cleaner should be a self-rinsing, foaming cleaner such as WEB® Coil Cleaner.

Pump Maintenance

Pump Access:

Remove the screws on the housing, then lift off. Unplug the pump drain line, then remove the screws holding the pump in place.

Cleaning the Pump Reservoir:

Once the screws are removed, lift off the top of the pump and set aside. Use a paper towel to wipe out the base of the pump.

Troubleshooting

Symptom	Cause	Solution
Display is Blank	Poor Connection	Verify that both ends of the power cord are plugged in
	Power Outage	Reset power
No Airflow	Filter is Dirty	Clean the filter
	Air Inlet or Outlet is Blocked	Clear the blockage
Error Code: E1	Humidity Sensor or Communication Error	Check to ensure that the sensor wire is connected at both ends. if no issues are visible, the sensor may be faulty.
Error Code: E4	Problem with Pump	Verify that the pump is properly installed and functioning. If so, unplug the unit for two minutes, then restart.
Error Code: LO	Room Temperature is below 33° F	Increase the room temperature so it is within operating range (above 33° F). If error still displays, check sensor.
Error Code: HI	Room Temperature is above 110° F	Decrease the room temperature so it is within operating range (below 110° F). If error still displays, check the sensor
E5 Error Code	Refrigerant Leak	Contact Your Installer for Assistance

Dehumidifier Storage

If the unit will be stored for an extended period of time, complete the following steps:

1. Turn off the unit and allow it to dry.
2. Clean out the pump reservoir.
3. Wrap and secure the power cord
4. Cover filter mesh.
5. Store in clean, dry space

Limited Warranty

All warranty benefits apply to the original owner only. Warranty cannot be transferred or assigned.

1 YEAR (FROM DATE OF PURCHASE): Alorair warrants the dehumidifier will operate free of defects in workmanship and materials. At its discretion, Alorair will repair or replace any malfunctioning components, free of charge (excluding transportation costs)

3 YEARS (FROM DATE OF PURCHASE): Alorair warrants the refrigeration circuit (compressor, condenser and evaporator) will operate free of defects in material or workmanship. At its discretion, Alorair will replace defective parts, including factory labor or refrigerant. This does not include transportation.

5 YEARS (FROM DATE OF PURCHASE): Alorair warrants the compressor, condenser, and evaporator will operate free of any defects in material or workmanship. At its discretion, Alorair will repair or replace the defective parts. This does not include labor, transportation, or refrigerant.

CUSTOMER RESPONSIBILITIES: In order to take advantage of the warranty service, the customer must do the following:

1. Customer must provide normal care and maintenance (including, but not limited to cleaning filters, coils and pumps)
2. Removal and re-installation of unit is the sole responsibility of owner.
3. If customer cannot return unit to certified repair center, all costs associated with freight shipment are borne by the customer. In addition, all duties related to freight shipments, including but not limited to palletizing, wrapping, labeling, and pickup are associated with customer.
4. If shipped, customer is responsible for all risk of loss or damage.

AlorAir Warranty Steps:

1. Once receive the goods, customers must log in www.alorair.com to fill out the warranty Registration form and submit to AlorAir company. We will receive your purchasing and installation information and save it. If no warranty registration is sent to us, warranty period will begin the day the shipment left the warehouse. Please be sure to record serial # and date of installation. You will need this information to receive the RA number.
2. If warranty service is necessary, customers must contact Alorair Tech Support by sales@alorair.com or local technical service phone to receive a Return Authorization (RA number). Once an RA has been issued, customers should bring the unit to a certified repair center. AlorAir will arrange the shipping to bring the unit back to the Alorair warehouse (at the expense of the customers) if customers are not available.
3. After the unit has been received by Alorair (whether at a repair center or the warehouse), Alorair will have an initial inspection. If it is determined to be invalid warranty claim (see exclusions below), customers have to pay for all associated repair costs and shipping costs for units repair.
4. Customers can pick up the unit after repair at their own expense for shipping. Units will have a rigorous testing before sending it back to customers
5. If the unit can no longer be fixed, and it is in the warranty period and determined to be valid claim, we will ship the customer a new unit within the same year warranty from the date of replacement.
6. After parts are repaired or replaced by AlorAir, the original warranty period continues to apply until meet its deadline. No extensions to the original warranty period.

EXCLUSIONS:

DAMAGE DUE TO THE FOLLOWING IS NOT COVERED UNDER WARRANTY

1. ACTS OF NATURE- INCLUDING BUT NOT LIMITED TO:

- FLOODING
- FIRE
- WATER DAMAGE
- HURRICANE/STORM DAMAGE

2. IMPROPER USAGE- INCLUDING BUT NOT LIMITED TO:

- POOL/SPA/TUB APPLICATIONS
- MISUSE, ABUSE, OR TAMPERING WHETHER INTENTIONAL OR ACCIDENTAL
- IMPROPER INSTALLATION OR DESIGN
- IMPROPER VOLTAGE
- LACK OF NORMAL CARE
- FAILURE TO FOLLOW INSTRUCTIONS

3. CORROSION

4. FREEZING

5. ANY ADDITIONAL COSTS DUE TO CHANGES IN LAWS OR BUILDING CODES

6. FREIGHT CHARGES

7. ANY COSTS DUE TO LOST PROFIT OR DELAY

8. DAMAGE TO PROPERTY

9. CAUSE BEYOND CONTROL

10. CONSUMABLE PARTS, INCLUDING BUT NOT LIMITED TO:

- FILTERS
- BATTERIES
- POWER CORDS
- VALVES
- SWITCHES
- RUBBER PARTS

11. DIRECT, INDIRECT, COLLATERAL OR INCONSEQUENTIAL DAMAGES OF ANY KIND

THE WARRANTIES AND LIABILITIES SET FORTH ARE IN LIEU OF ALL OTHER WARRANTIES EXPRESSED OR IMPLIED, IN LAW OR IN FACT, INCLUDING IMPLIED WARRANTIES OF MERCHANTABILITY AND FITNESS FOR PARTICULAR PURPOSE. Alorair's total liability, regardless of nature of claim shall not exceed original purchase price of the product if a product or component is replaced while under warranty, the applicable warranty period shall not be extended beyond the original warranty time period.

The foregoing shall constitute the total liability of seller in the case of defective performance of all or any of the equipment or services provided to buyer. buyer agrees to accept and hereby accepts the foregoing as the sole and exclusive remedy for any breach or alleged breach of warranty by seller.

Any dishonesty or fraud in connection with Alorair warranty thoroughly voids all warranty policies. Alorair expressly reserves the right to pursue legal action in the event of dishonesty, fraud, or attempted fraud.

